

Model: PFSPTAM3

Features:

Self-priming centrifugal, solids handling, frame mounted pumps designed for Industrial and Municipal applications.

- **SUCTION/DISCHARGE:** 3" x 3", ASA 125lb Spool Flanges included
- **LIQUID TEMPERATURE:** 160°F
- **CASING:** Cast Iron ASTM A-48 Class 30, Maximum Operating pressure 87 psi
- **IMPELLER:** 2 Vane semi-open type. Ductil Iron, Handles 2-1/2" diameter spherical solids
- **SHAFT:** 420 Stainless Steel
- **SHAFT SLEEVE:** 316 Stainless Steel
- **COVER PLATE:** Gray Iron ASTM A-48, Class 30, Removable, Adjustable, Weight 30 lbs.
- **WEAR PLATE:** Replaceable, Steel
- **BEARING HOUSING:** Gray Iron ASTM A-48, Class 30
- **SEAL PLATE:** Gray Iron ASTM A-48, Class 30
- **PAINT:** Air dry enamel
- **BEARING-DRIVE END:** Open, Single Row, Ball, thrust load
- **BEARING-PUMP END:** Open, Single Row, Ball, radial load
- **LUBRICATION:** Bearing - SAE No. 30 non detergent oil, pump includes oil level sight gauge
- **SEAL:** Cartridge Type, mechanical, oil lubricated. Tungsten carbide rotating and stationary faces, Viton elastomers (Dupont Viton® or equivalent). 316 Stainless steel cage and spring
- **CHECK VALVE:** Neoprene Flap type with steel weights
- **GASKET:** Buna-N, compressed synthetic fibers, PTFE, vegetable fiber, cork and rubber
- **O-RINGS:** Buna-N
- **HARDWARE:** Standard plated Steel
- **PRESSURE RELIEF VALVE:** Brass
- **OPTIONAL EQUIPMENT:** Flexible coupled assy, with base OSHA guard and electric motor.
- **WARRANTY:** 1 year
- **WEIGHT:** Pump - 404 lbs, Crated - Approx. 535 lbs

 **WARNING:** CANCER AND REPRODUCTIVE HARM-
WWW.P65WARNINGS.CA.GOV

WARNING! - DO NOT use in explosive atmosphere or for pumping volatile flammable liquids.



Self-Priming Centrifugal, Frame Mounted, Solids Handling Pumps Universal Drive 2-1/2" Solids

IMPELLER SIZES:

Standard Impeller will be supplied unless otherwise noted.

- 8.75" Dia. - Standard
- 8.50" Dia.
- 8.25" Dia.
- 8.00" Dia.
- 7.75" Dia.



Power-Flo Pumps & Systems

a Power-Flo Technologies company

877-24PUMPS • fax: 516-812-6897 • www.powerflopumps.com

Self-Priming Centrifugal Pumps - PFSPTAM - 3" x 3"

Sect.
SP
Page
39
Rev.
02/2021

Self-Priming Centrifugal Pumps - PFSPTAM - 3" x 3"

Model: PFSPTAM3
8.75" Impeller Dia - Standard, Various RPM

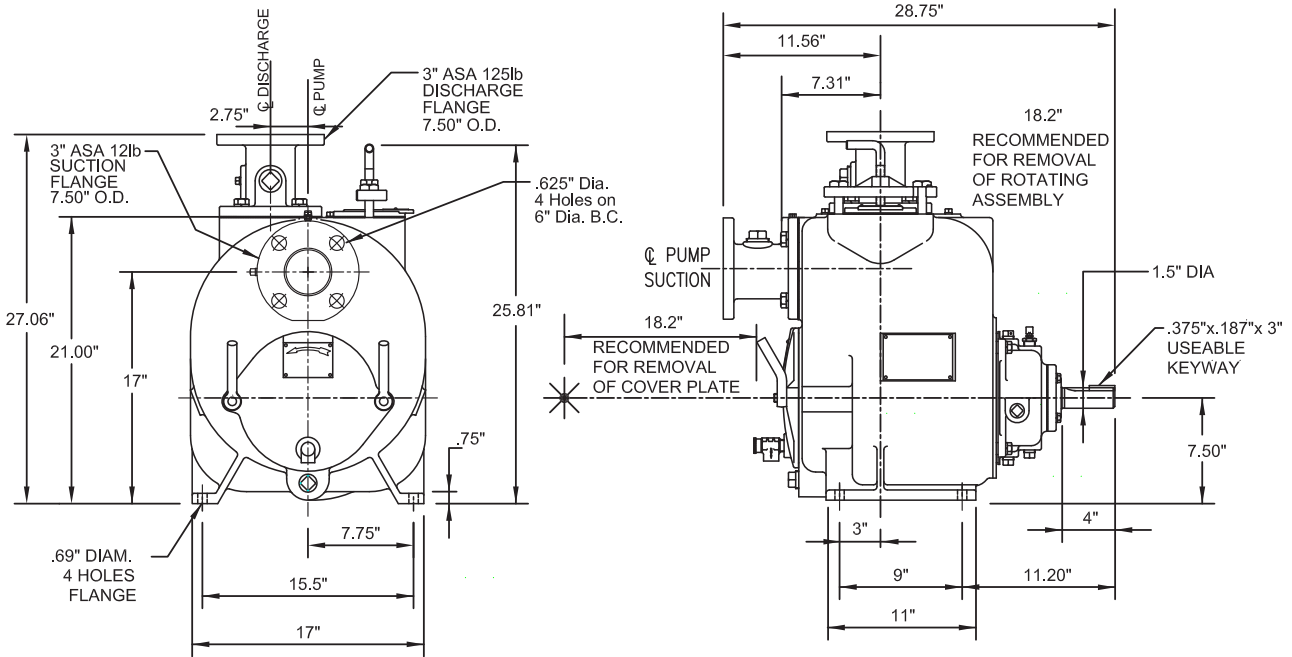

8.75" Impeller Dia - Standard, Various RPM

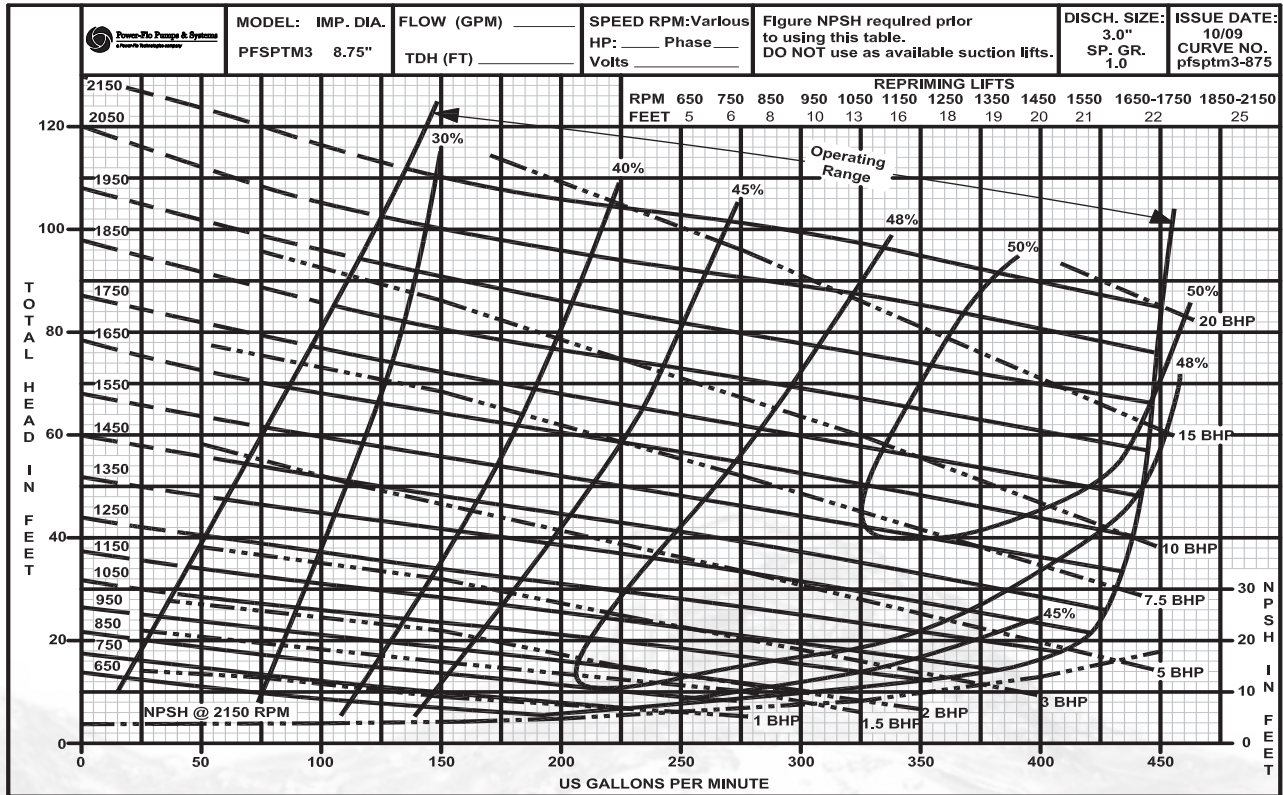

Model: PFSPTAM3
8.50" & 8.25" Dia. Imp. at Various RPM

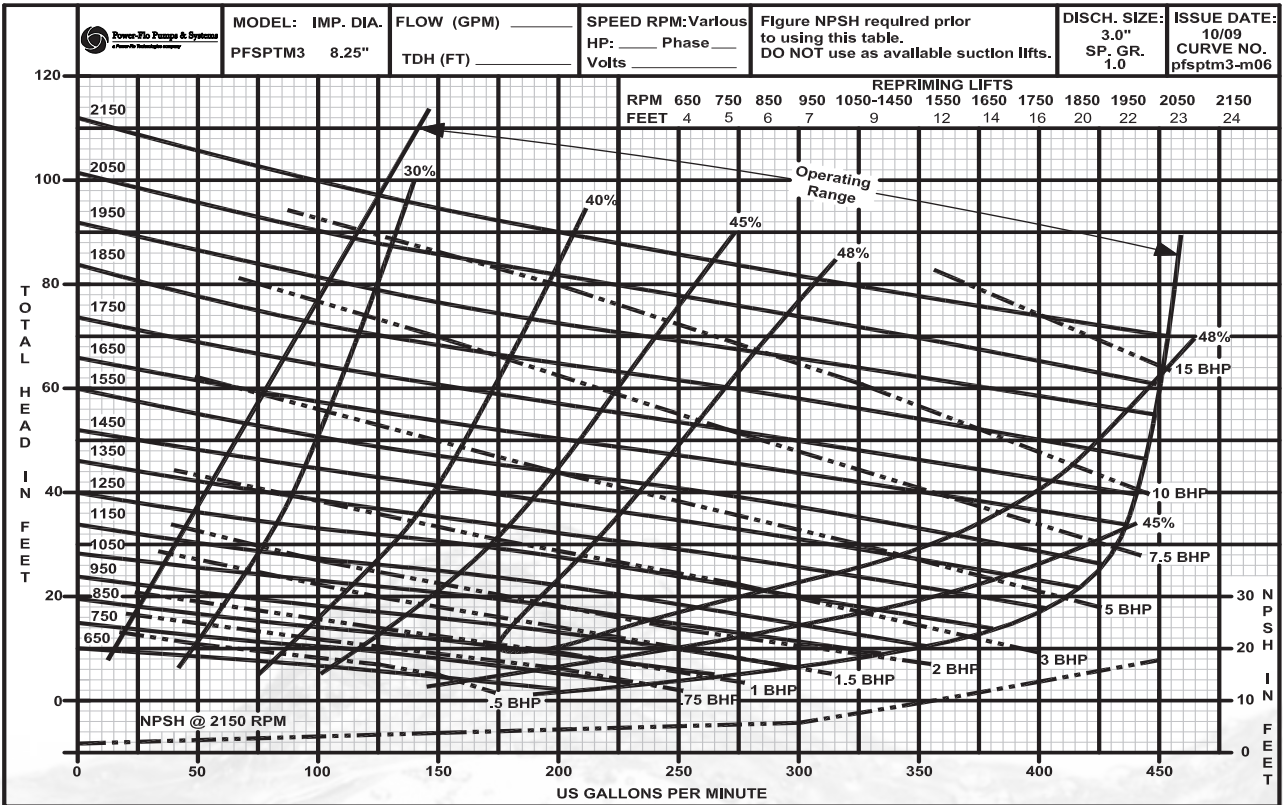
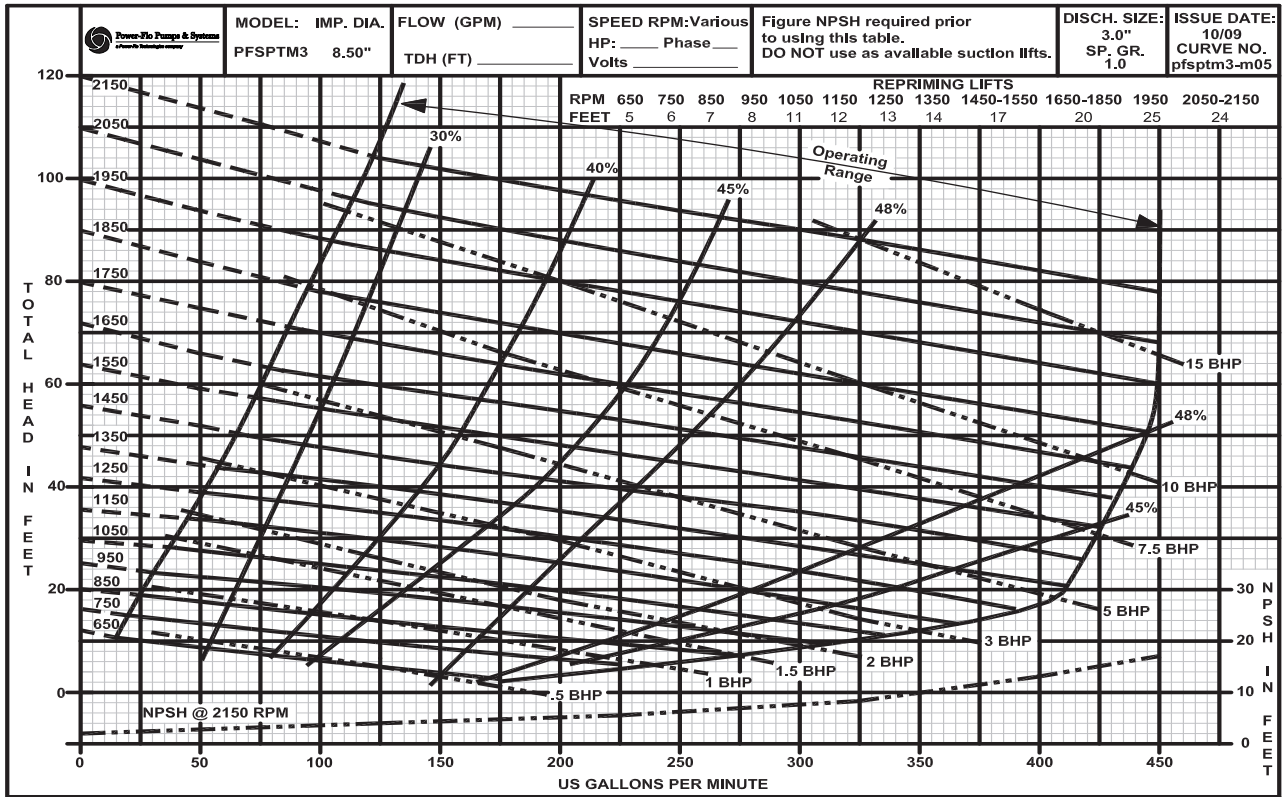

Self-Priming Centrifugal Pumps - PFSPTAM - 3" x 3"



Power-Flo Pumps & Systems

a Power-Flo Technologies company

877-24PUMPS • fax: 516-812-6897 • www.powerflo pumps.com

Sect. SP
 Page 41
 Rev. 02/2021

Model: PFSPTAM3
8.00" & 7.75" Dia. Imp. at Various RPM

Self-Priming Centrifugal Pumps - PFSPTAM - 3" x 3"

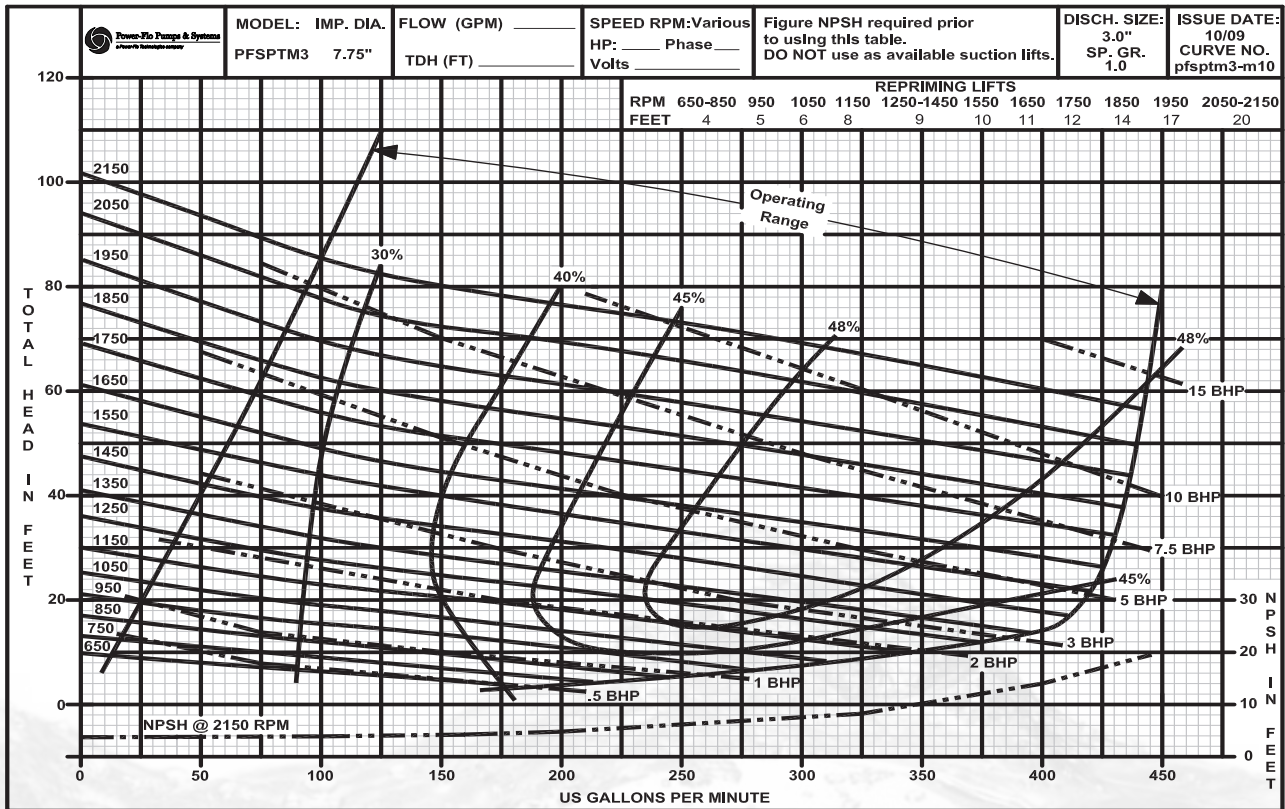
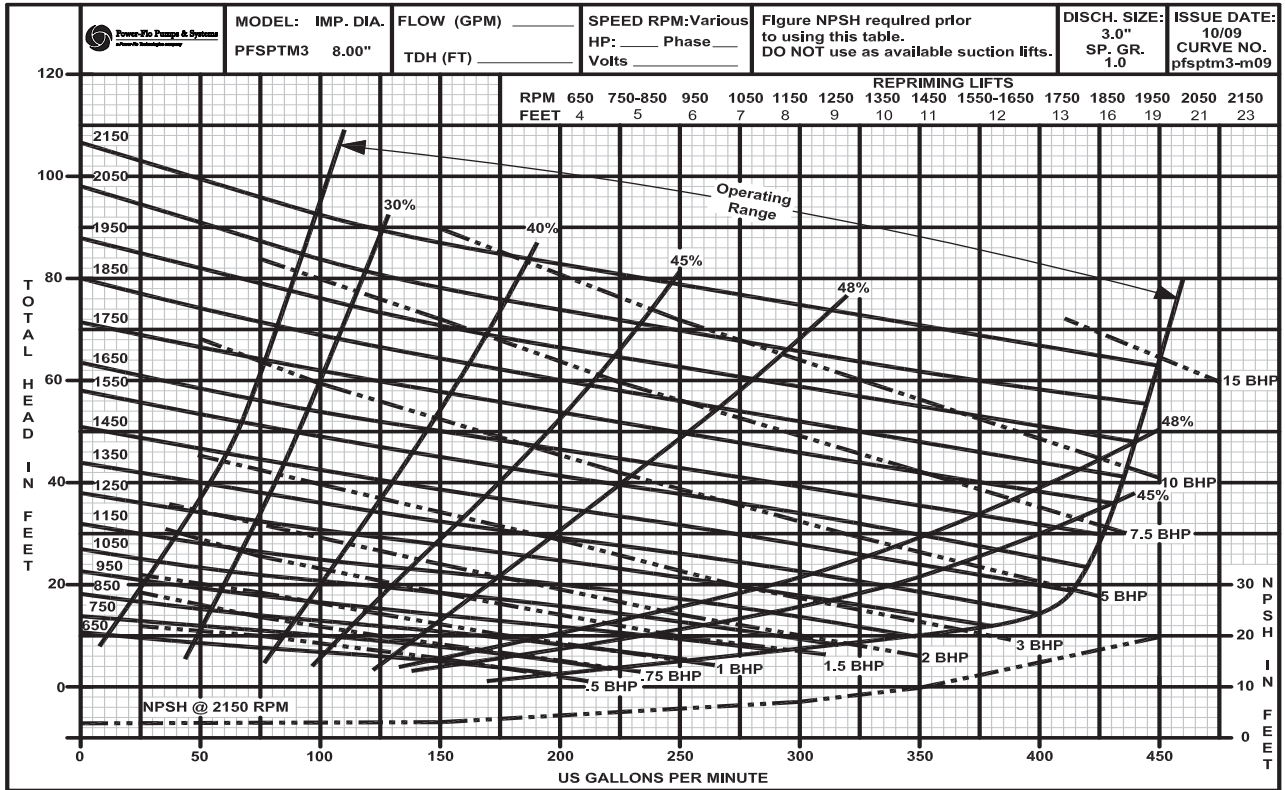

Model: PFSPTAM3
Various Impeller Dia, 1750RPM & 1450RPM

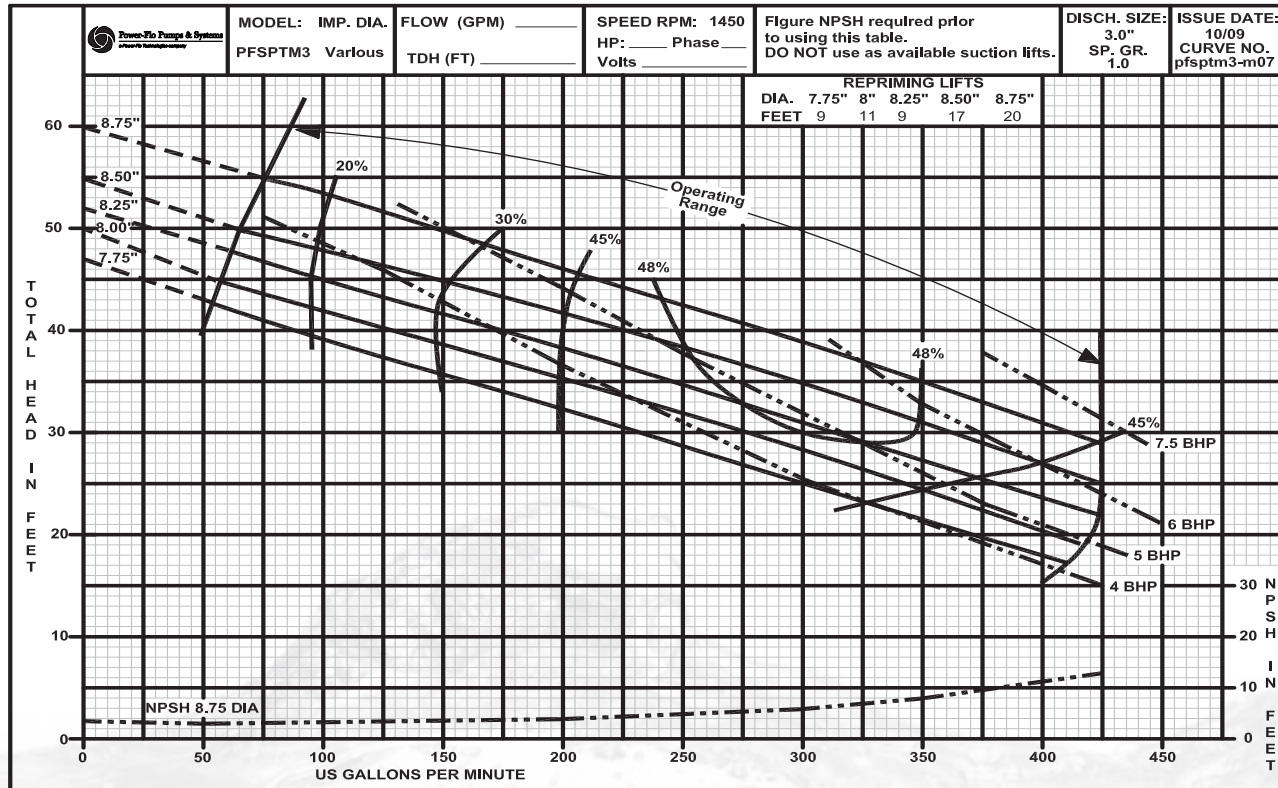
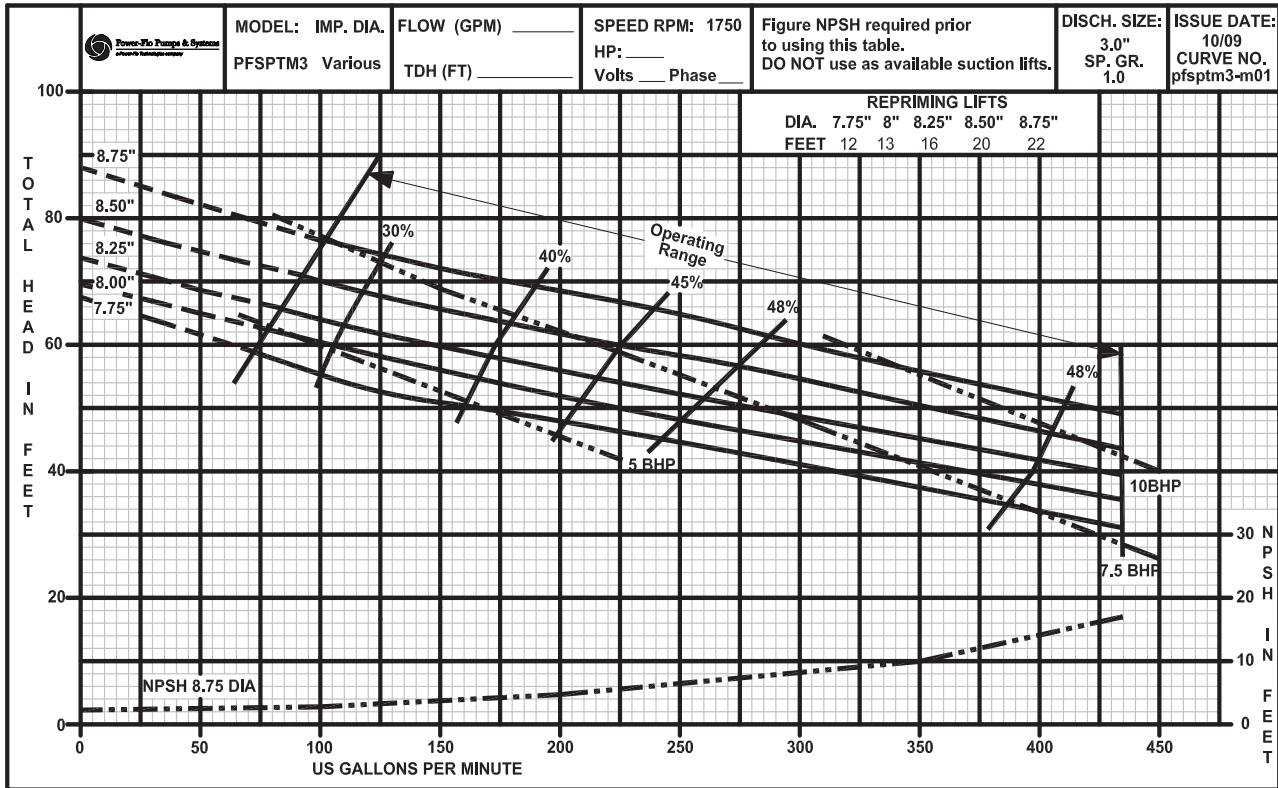

Self-Priming Centrifugal Pumps - PFSPTAM - 3" x 3"



Power-Flo Pumps & Systems
 a Power-Flo Technologies company

877-24PUMPS • fax: 516-812-6897 • www.powerflo pumps.com

Sect. SP
 Page 43
 Rev. 02/2021

Model: PFSPTAM3
Various Impeller Dia, 1150RPM & 950RPM

Self-Priming Centrifugal Pumps - PFSPTAM - 3" x 3"

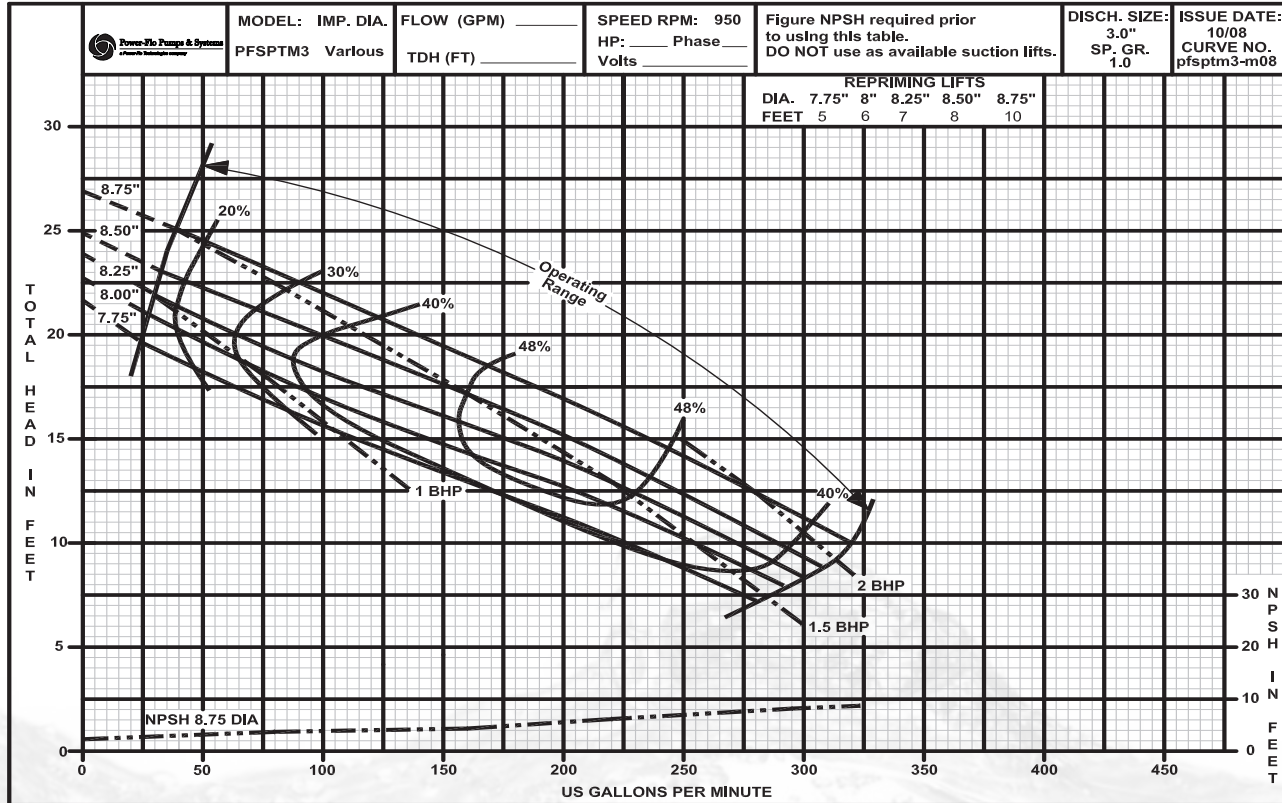
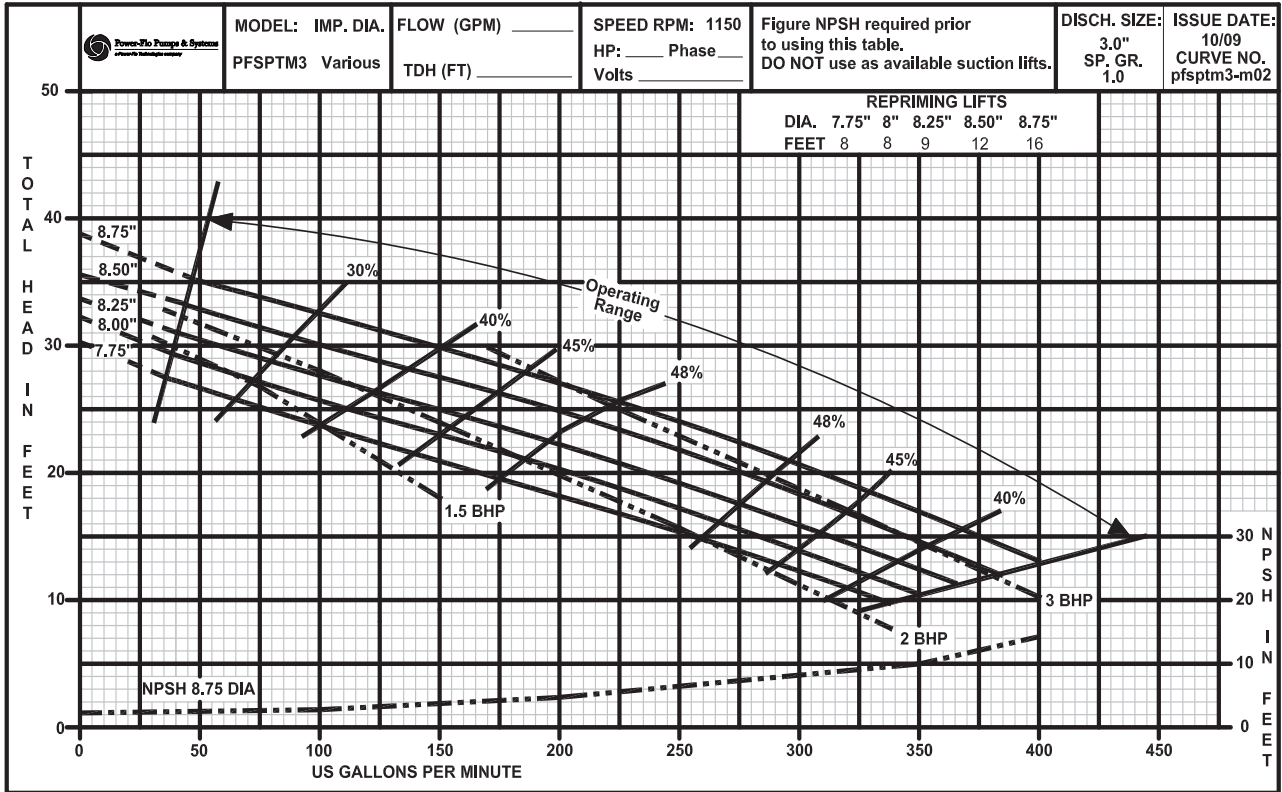

Model: PFSPTAM3
Various Impeller Dia, 860RPM

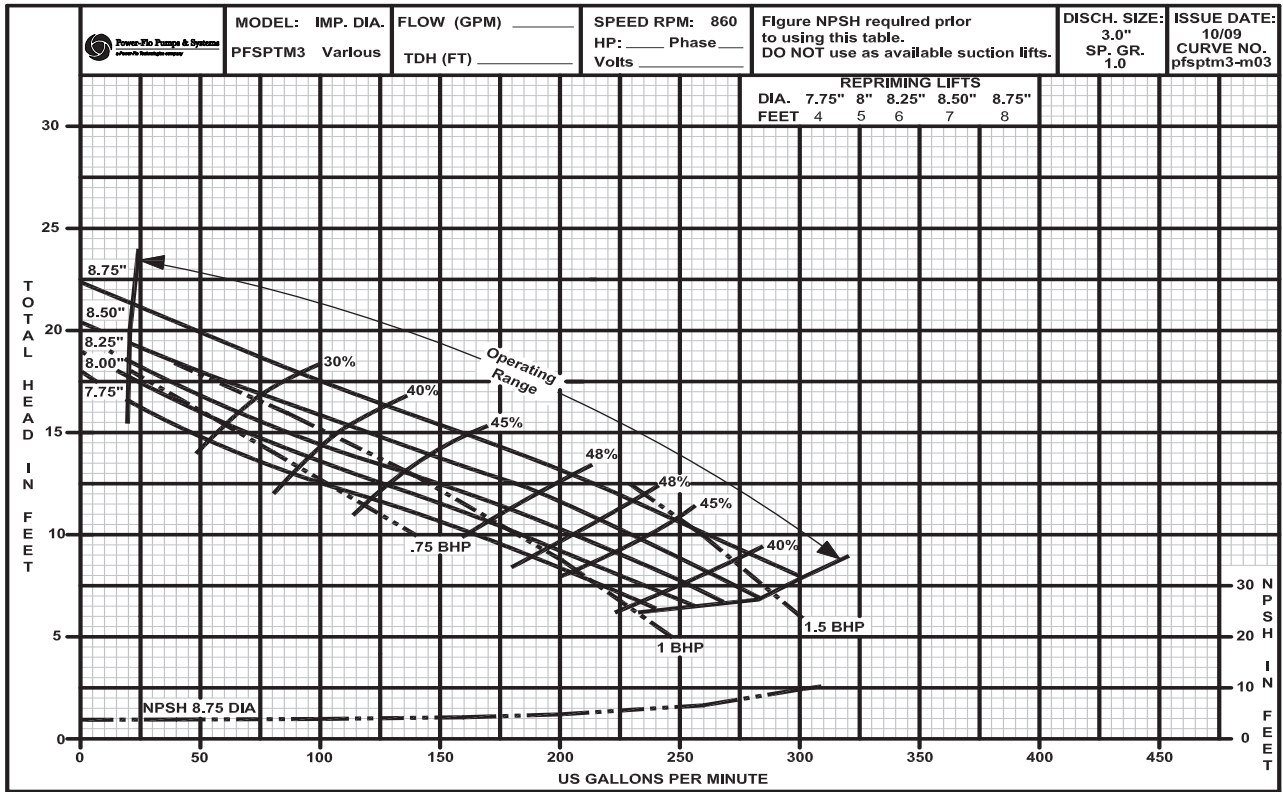

Self-Priming Centrifugal Pumps - PFSPTM - 3" X 3"



Power-Flo Pumps & Systems

a Power-Flo Technologies company

877-24PUMPS • fax: 516-812-6897 • www.powerflopumps.com

Sect. SP
Page 45
Rev. 02/2021